



wooden activity kitchen

user guide

1410120215
Early Learning Centre®
Watford WD24 6SH England.

Customer Service Department
0371 231 3513

parts checklist

GB To be assembled by an adult. Screwdriver not included.

F A monter par un adulte. Tournevis non fourni.

E A montar por un adulto. Destornillador no incluido.

I Dev'essere montato da un adulto. Cacciavite non incluso.

P A ser montado por um adulto. Chave de fenda não incluíu.

Pl Do zmontowania przez osobę dorosłą. Śrubokręt nie wliczone.

H Felnött fűjja fel. Csavarhúzó nem tartalmazza.

Ro A se monta de către un adult. Șurubelnița nu sunt incluse.

Rus Сборку должны осуществлять взрослые. Отвертка не включенная.

Ukr Прилад мають збирати дорослі. Викрутка не входить.

Si Sestaviti ga mora odrasla oseba. Skrutkovač nie je súčasťou dodávky.

Sb Treba da ga sastavi odraslo lice. Odvijač nije uključen.

Cr Treba ga sastaviti odrasla osoba. Odvijač nije uključen.

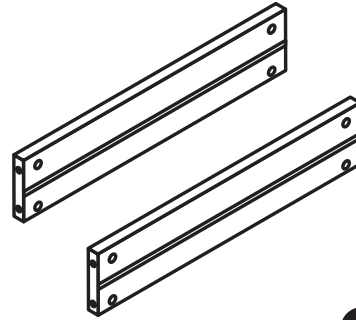

A
x2



B
x12

M4

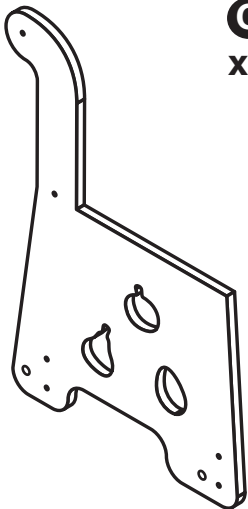

C
x1

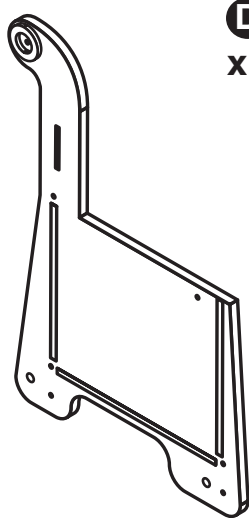

D
x1



2,5 x 18 MM

E
x6

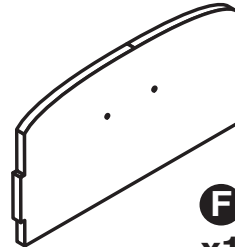

F
x1



G
x1

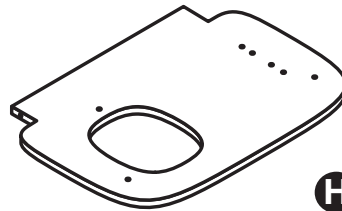

H
x1



I
x1



3.5 x 25 MM

J
x1



K
x2

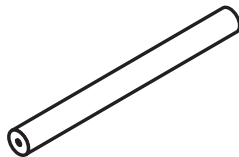

L
x1



3,5 X 35 MM

M
x2

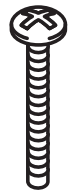

M4 x 35 MM

N
x12

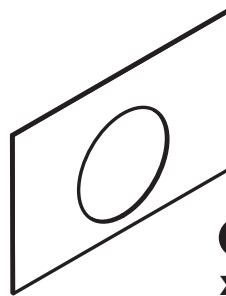

O
x1

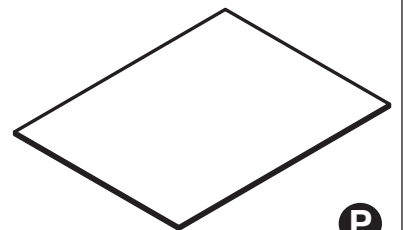

P
x1

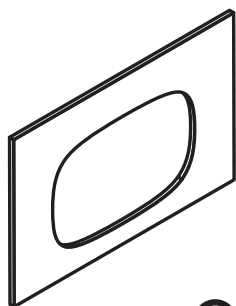

Q
x1



M6 X 20 MM

R
x4



S
x4



T
x4



Ø 12 MM

U
x4



Ø 10 MM

V
x4



M6 X 20 MM

W
x4



X
x1



a
x1



b
x1



c
x1



d
x1



e
x1



f
x1



g
x1



h
x1

assembly

