

assembly

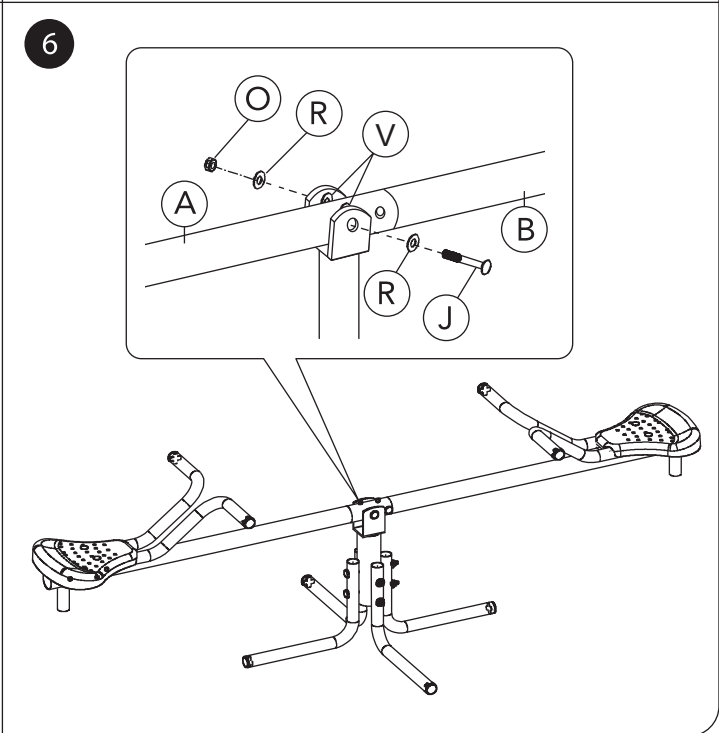

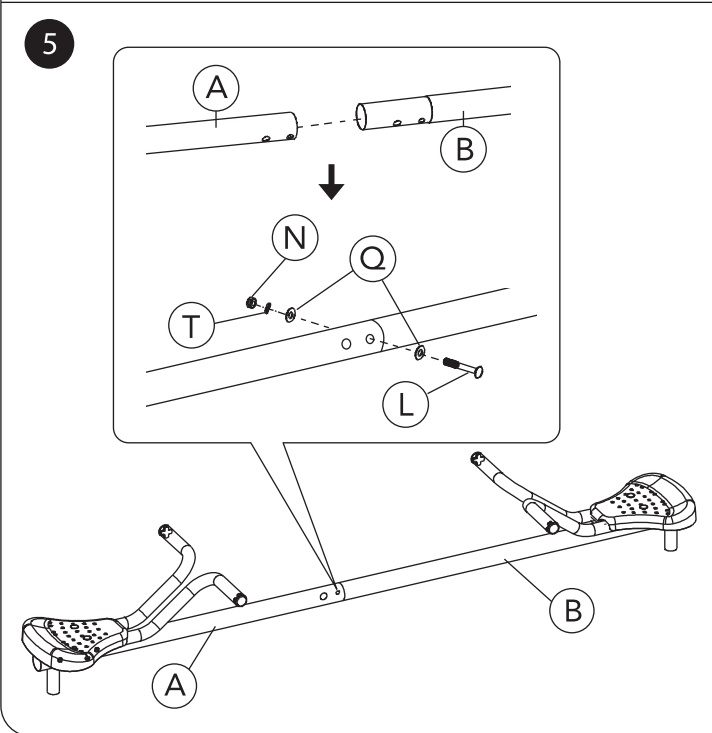

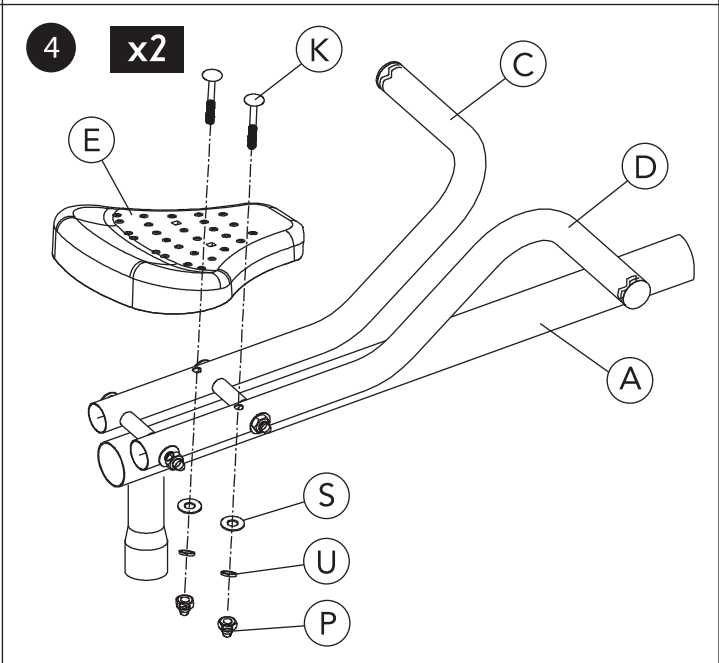

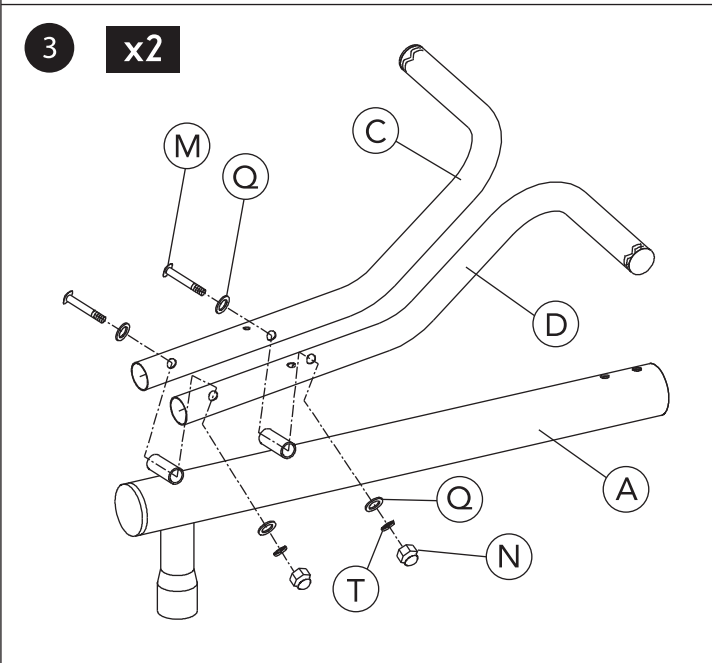
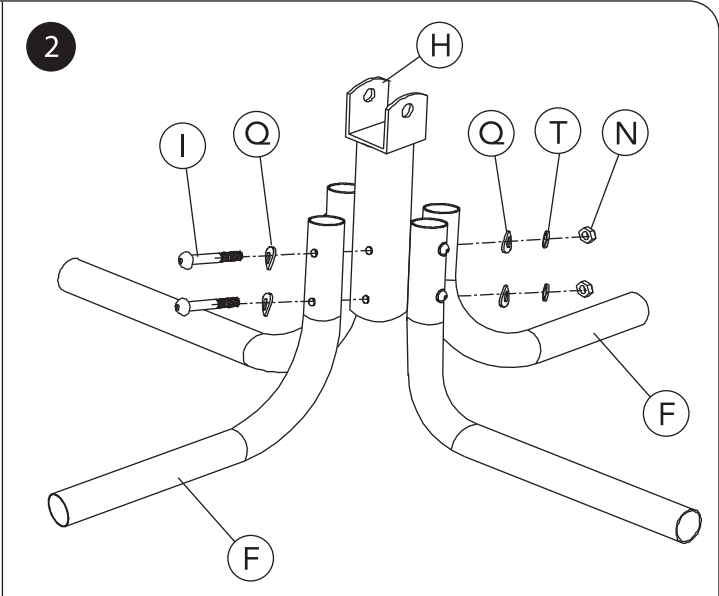
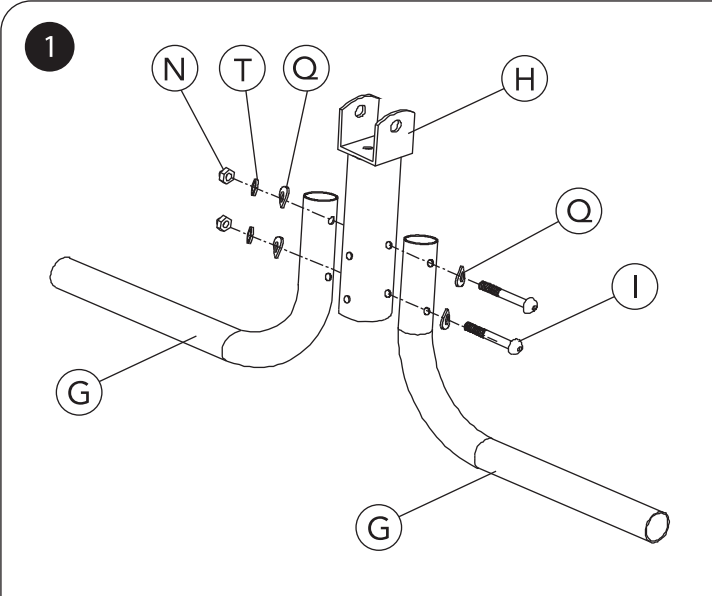







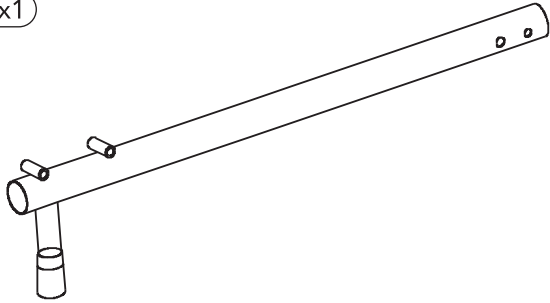
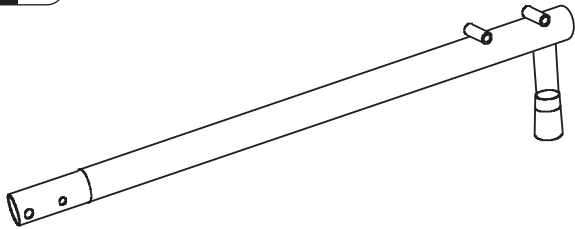
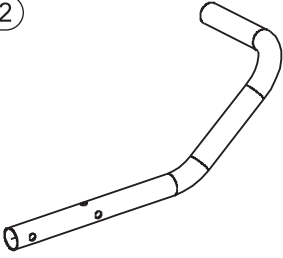
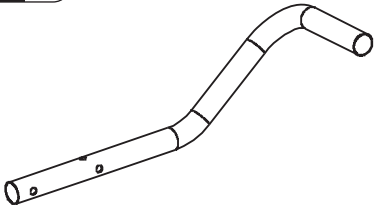
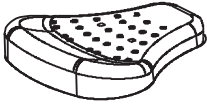
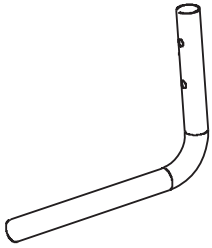
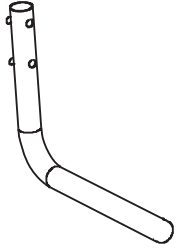

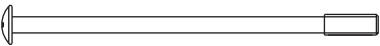
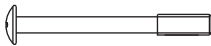

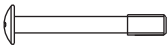
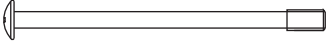
see saw
user guide

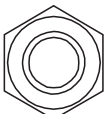
142640 0915

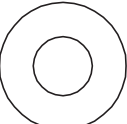
Early Learning Centre®
Watford WD24 6SH England.

Customer Service Department
0371 231 3513
UK Spare Parts and Advice Line
0170 220 8182

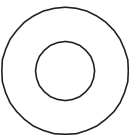
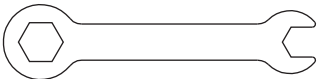
contents

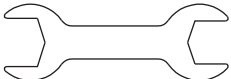
<p>A x1</p> 		<p>B x1</p> 		
<p>C x2</p> 		<p>D x2</p> 		
<p>E x2</p> 				
<p>F x2</p> 		<p>G x2</p> 		
<p>H x1</p> 				
<p>I x4 M8 x 110mm</p> 	<p>J x1 M10 x 60mm</p> 	<p>K x4 M6 x 36mm</p> 	<p>L x1 M8 x 48mm</p> 	
<p>M x4 M8 x 94mm</p> 	<p>N x9 M8</p> 	<p>O x1 M10</p> 	<p>P x4 M6</p> 	
<p>Q x18 Ø8.5*Ø19</p> 	<p>R x2 Ø10.5*Ø20</p> 	<p>S x4 Ø6.5*Ø14</p> 	<p>T x9 Ø8.5*Ø13.5</p> 	<p>U x4 Ø6.5*Ø10</p> 
<p>V x2 Ø10.5*Ø20</p> 	<p>W x1</p> 	<p>X x1</p> 	<p>Y x1</p> 	

warnings

- Misuse and abuse of this product can result in injury.
- Read instructions before assembly or using this product. Retain Instructions.
- Always inspect product before use , checking for worn , defective or missing parts.
- Adult Supervision at all times.
- Before you start assembly please check all parts are included.
- NOT suitable for children under 36 months. Small parts choking hazard.
- Adult supervision is required at all times. Never leave children unattended.
- Product MUST be assembled and checked by an adult.
- This product is only intended for Outdoor & Domestic use.
- Only one child per ride seat at any one time.
- Age recommendation for this product is 3-8years.
- Max. user weight for See Saw seat is 30 kgs.
- DO NOT stand on See Saw Seat.
- Product must be assembled and used on a flat and level surface at least 2 metres (7.5 feet) from any structures or obstructions such as fences, walls , garden borders, washing lines, electrical cables.
- Ensure the product is installed over a soft surface, such as grass or sand, or wood bark which should have a depth of minimum 15 cm (6 inches).Installation area should be regularly checked and any shock absorbing materials replenished to maintain a correct depth regarded suitable for the product otherwise injuries may occur from a fall.
- DO NOT install the unit over concrete, asphalt, gravel or any hard surface which may cause injury should a fall occur.
- DO NOT allow children to use the product until it has been properly assembled, and checked by an adult.
- Ensure children wear suitable clothing whilst using the product. Do not allow loose clothing, clothing with draw - strings, jewellery or any article of clothing that might be potentially hazardous whilst using the product.
- DO NOT let children use this equipment in any manner other than the correct intended use.
- DO NOT allow children to dis-mount any ride or swing whilst still moving.
- DO NOT allow children to wander into the play area when the product is in use.
- DO NOT allow children to climb or play on the product whilst the product is wet as slips or falls may occur.
- DO NOT allow children to swing empty rides as they may strike and injure other children.
- DO NOT attach items to the product that are not specifically designed for use with the product; such as, but not limited to, cables, skipping ropes, nursery swing seats as they may cause injury.
- Remove and dispose of all packaging materials before the product is used.
- Once assembly is complete carefully check the equipment before use to ensure all parts are correctly assembled. Check all nuts and bolts are tightened. If you find any problems do not allow children to use the product until it is fit for use. If these checks are not carried out the product could over-turn or otherwise become a hazard.
- Check metal sections and components for signs of corrosion.
- Discontinue use if any weakening or breakage is found.
- The product has maintenance instructions highlighting the need to carryout checks and maintenance of the main parts at regular intervals.
- Please retain these instructions for future reference.
- Teach children to use the product correctly and sit in the centre of ride seats whilst in use.

tips

It will take 2 people around 45 mins to assemble this product.

before you start

- We suggest you spend some time reading this guide before following the simple step-by-step assembly instructions.
- Do not discard any of the packaging until you have checked that you have all parts and fittings listed. When discarding packaging take care and consideration for others and the environment.
- When assembling this product be aware of the safety of yourself and others.
- Because of the size of this product we suggest that you assemble it in the area intended for use.
- Some of the assembly will be easier with two people. Seek assistance when lifting large or heavy items.
- Assemble this product on a clean, flat and level surface e.g. the cardboard packaging.
- Keep any tools provided or spare fittings for future use. Only use the tools specified.
- Assemble all parts loosely, by hand, before tightening any bolts or fixings.

tightening nuts & bolts

- At the start of assembling DO NOT FULLY tighten bolts / nuts all the way so as to allow some possible adjustment for ease of assembly.
- DO NOT use pliers to tighten up screws as they can cause damage to paintwork and nuts and bolts.
- After all major components are assembled go back over all bolts and nuts and properly tighten all before using the product.

maintenance

- Carry out checks and maintenance of the main frame parts- cross beam, legs, nuts, bolts and rides before each play session and at least every two weeks.
- Check all nuts, bolts and fittings for tightness and tighten if required.
- Check unit for sharp edges which may have occurred during shipping, assembly, abuse or everyday usage. Replace if required.
- Check see saw seats for any evidence of deterioration, cracks or exposed edges which could cause injury.
- Check to ensure all rides are correctly fixed to the top beam according to the instructions.
- Oil all metallic moving parts monthly during the main usage period.
- To help maintain the products appearance, occasionally clean the seats and metal framework with a damp cloth lightly – but do not use abrasive chemical cleaners.
- When you wish to disassemble or dispose of the product please completely disassemble the unit and discard of it in a safe place and manner so as not to present any hazard to any individual.